

Jameson Vinyl/PVC

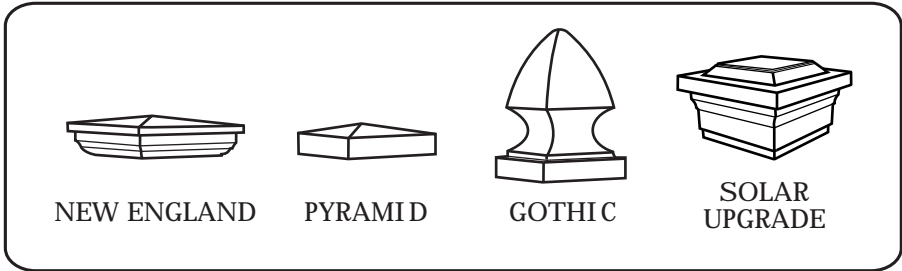
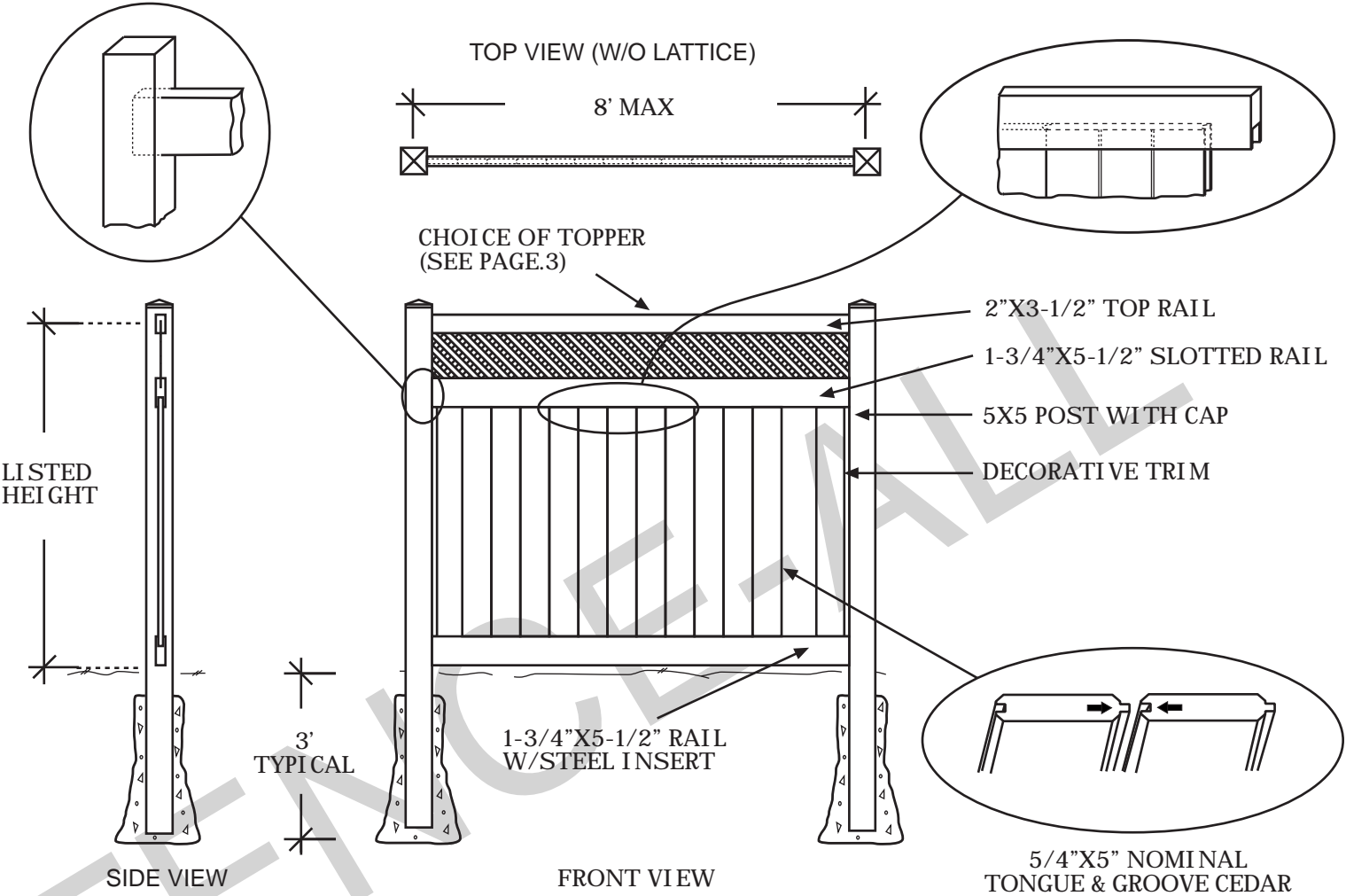

CHOICE OF CAP

NOTES:

- Green Teak lattice/jail bar/rails are substituted with Adobe.
- Clearance below the fence isn't included in height calculations.
- We reserve the right to make changes or improvements to our designs without notice.

Jameson Vinyl/PVC Gate

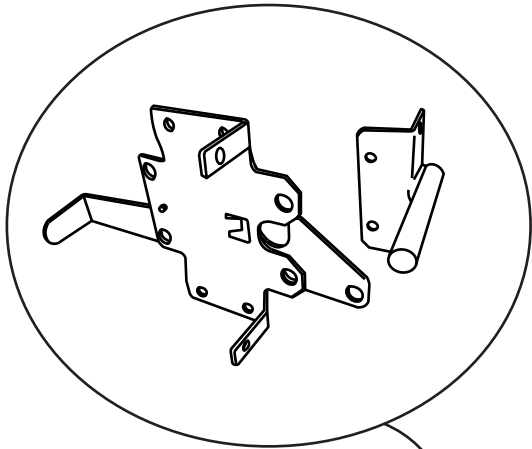

FINGER AND CATCH
TYPICALLY INSTALLED
@4'6" H MIN

TYPICALLY
1" SPACE ON
LATCH SIDE

TYPICALLY
1/2" SPACE
ON HINGE
SIDE

OPTIONAL 2"X3-1/2" GATE
BRACE TYPICALLY
INSTALLED @7'H MIN

5X5 POST
TYPICAL

TYPICALLY 1-1/2"
SHORTER THAN
MATCHING FENCE

2" to 4"

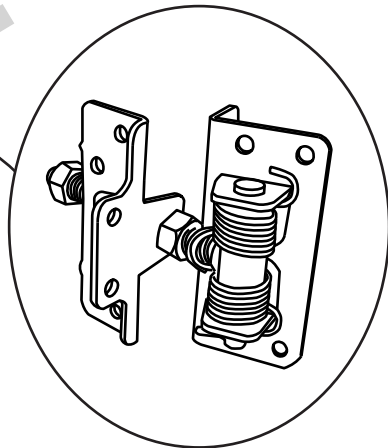

HINGES ADJUST TO
SET GATE ALIGNMENT

NOTES:

- Green Teak lattice/jail bar/rails are substituted with Adobe.
- Clearance below the fence isn't included in height calculations.
- We reserve the right to make changes or improvements to our designs without notice.

Topper Styles +

FILL MATCHES FENCE

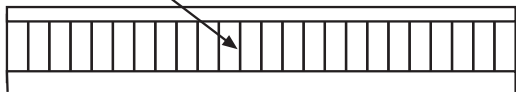

BOARD

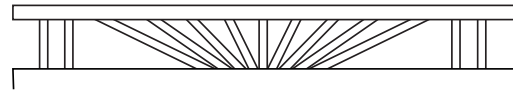

SUNBURST

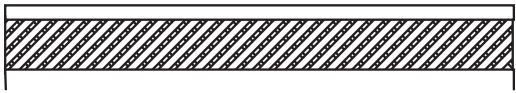

LATTICE

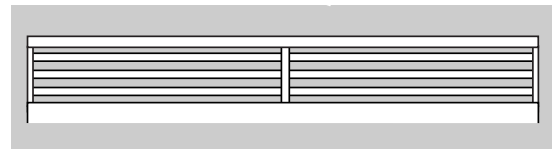

HORIZONTAL JAIL BAR

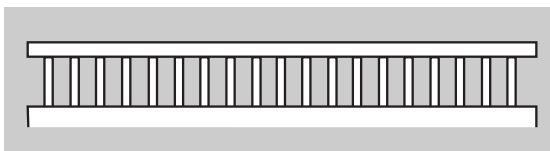

JAIL BAR

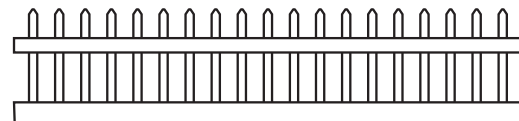

STRAIGHT PICKET

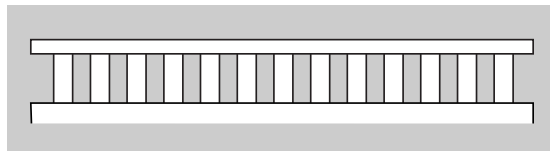

JAIL BAR THREE



STRAIGHT LIBERTY IRON

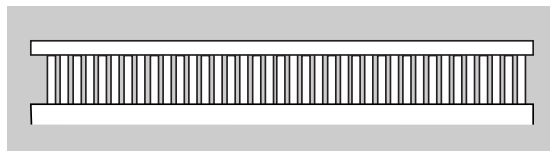

PRIVACY JAIL BAR

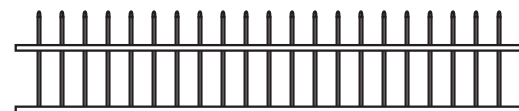

STRAIGHT MARQUEE IRON

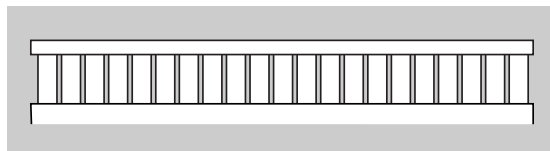

PRIVACY JAIL BAR THREE

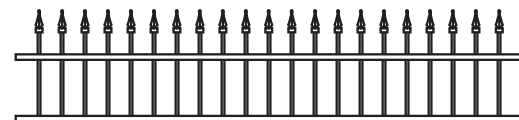

STRAIGHT ROCKEFELLER IRON

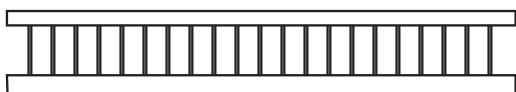

ROUND 3/4" METAL

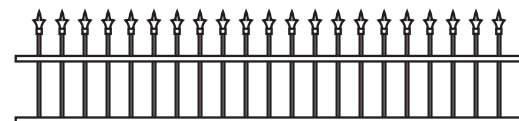

STRAIGHT EMPIRE IRON

NOTES:

• Prices vary depending on topper choice.