

# Grand Emerald Vinyl/PVC

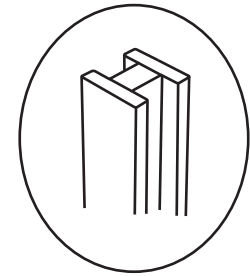

GREEN TEAK FENCES USE H-POSTS INSTEAD OF SQUARE POSTS

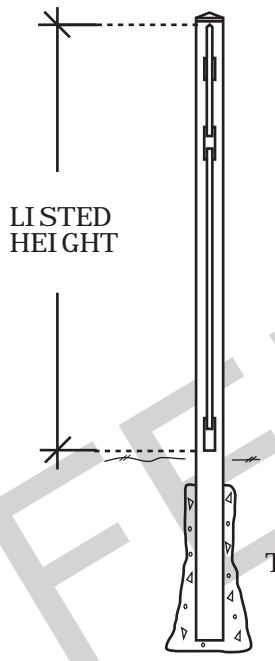
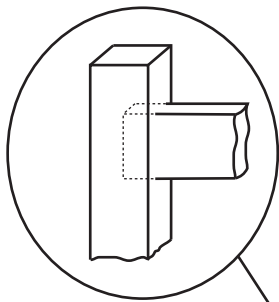

CHOICE OF TOPPER (SEE PAGE.3)

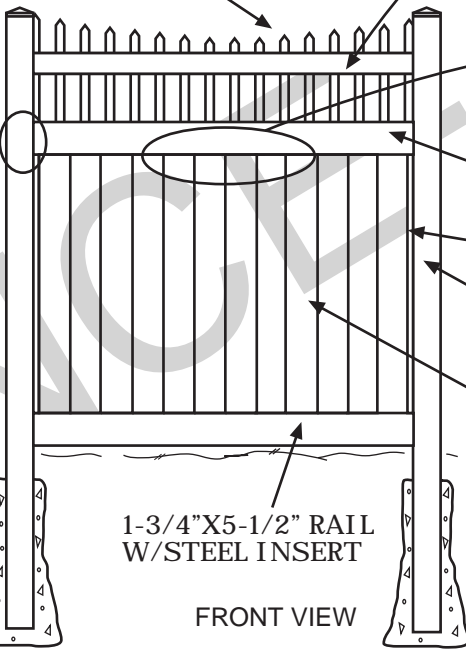

2"X3-1/2" TOP RAIL

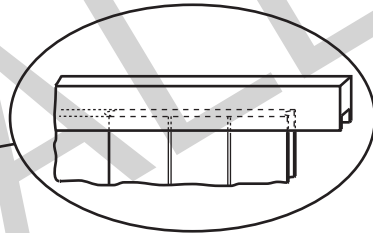

1-3/4"X5-1/2" SLOTTED RAIL

DECORATIVE TRIM

5X5 ROUTED PVC POST

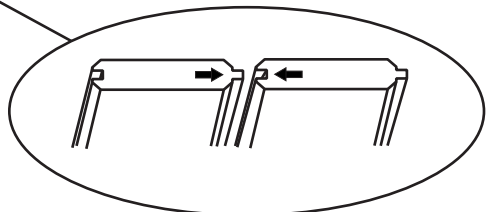

1-3/4"X5-1/2" RAIL W/STEEL INSERT

5/4"X5" NOMINAL TONGUE & GROOVE CEDAR

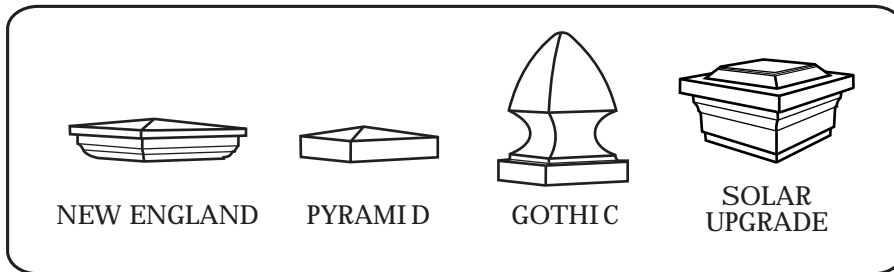

CHOICE OF CAP

NOTES:

- Green Teak jail bar/rails are substituted with Adobe.
- Clearance below the fence isn't included in height calculations.
- We reserve the right to make changes or improvements to our designs without notice.

# Grand Emerald Vinyl/PVC Gate

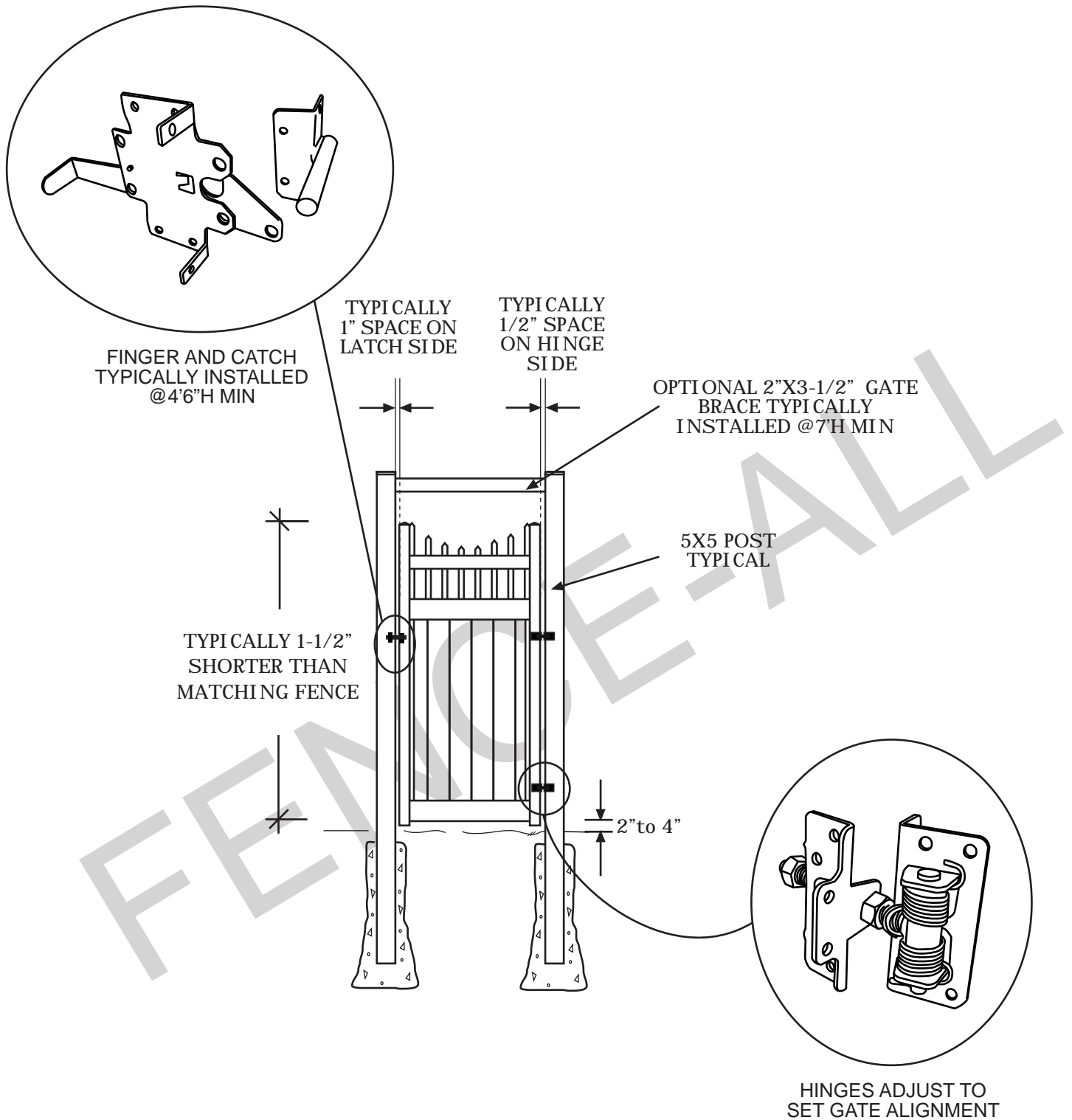

**NOTES:**

- Green Teak jail bar/rails are substituted with Adobe.
- Clearance below the fence isn't included in height calculations.
- We reserve the right to make changes or improvements to our designs without notice.

# Topper Styles ++

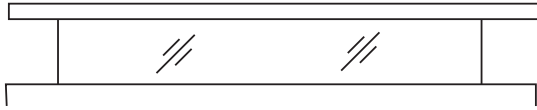

GLASS



HUDSON ALUMINUM

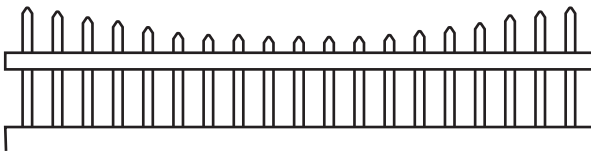

CONCAVE PICKET

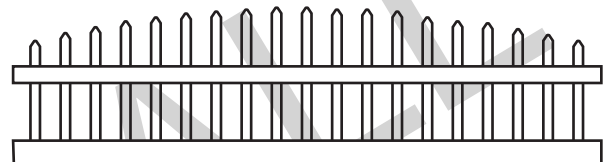

CONVEX PICKET

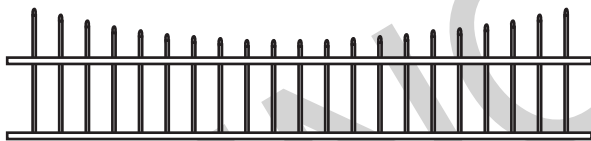

CONCAVE MARQUEE IRON

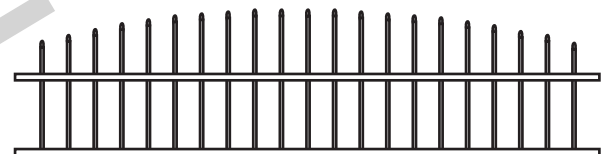

CONVEX MARQUEE IRON

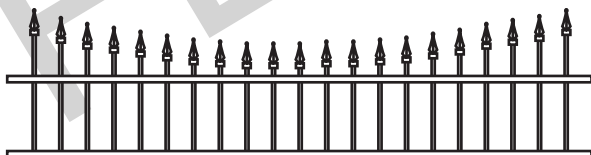

CONCAVE ROCKEFELLER IRON

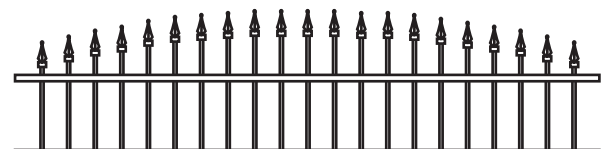

CONVEX ROCKEFELLER IRON

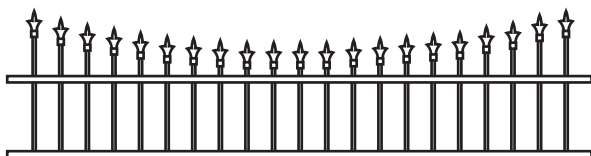

CONCAVE EMPIRE IRON

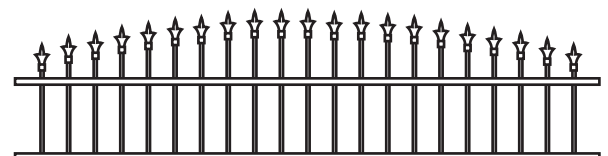

CONVEX EMPIRE IRON

NOTES:

- Prices vary depending on topper choice.